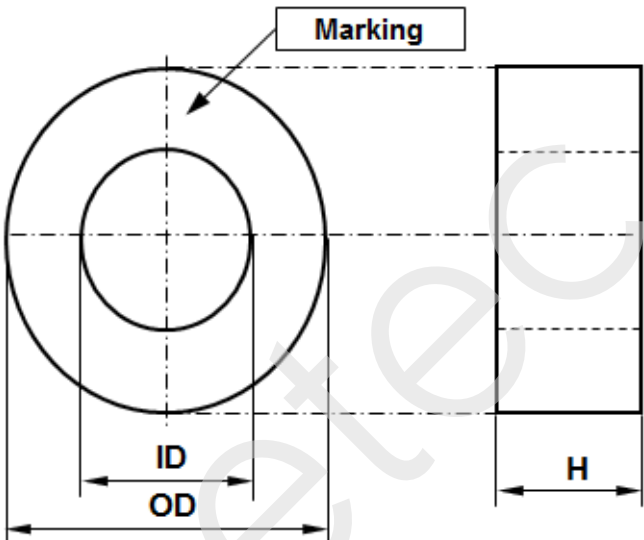

CONFIDENTIAL - Reproduction, publication and dissemination of this publication, enclosures hereto and the information contained therein is prohibited without MAGNETEC's prior written consent.

Client:	MAGNETEC	Magnetec P/N:	M-1204		
Client's P/N:	/	PS Index:	01	PS Revision:	01
Subject:	EMC Wandler				

1. Mechanical Outline	
Nominal equivalent round core: 20 x 12,5 x 8 Finished product dimensions: OD ≤ 22,5 ID ≥ 10,3 H ≤ 10 [dimensions] = mm	

2. Core data (nominal values)			
Core material:	NANOPERM®	$L_{Fe} = 5,01 \text{ cm}$	$A_{Fe} = 0,22 \text{ cm}^2$
Permeability level:	~4000	@ frequency 10 kHz	@ H peak 2,82 mA/cm

3. Inspection values (at room temperature, unless otherwise stated)			
Measured value	Measurement limits	Frequency	$I_{eff} \times N$ [mA x turn]
AL [μH]	1,56 - 3,11	10 kHz	10
AL [μH]	1,56 - NA	100 kHz	10

4. Core finishing	
Type:	Cased
Marking:	MAGNETEC M-1204-01 YM (YM = Year/Month), acc. to IEC 60062 6.1.1
Packaging:	75 pcs. per layer; 7 layers per carton box; PU = 525 pcs.

5. Comments
Visit http://www.magnetec.de/fileadmin/pdf/pb_ds.pdf for further information.

Index / Revision	Alteration	Date
01 / 01	First issue	04.07.2017

Created:	M. Pádár 04.07.2017	Approved (Techn):	F. Zámbořszky 28.07.2017	Approved (Quality):	G. Zsák 28.07.2017	Released:	P. Seiz 31.07.2017
-----------------	------------------------	--------------------------	-----------------------------	----------------------------	-----------------------	------------------	-----------------------

CONFIDENTIAL - Reproduction, publication and dissemination of this publication, enclosures hereto and the information contained therein is prohibited without MAGNETEC's prior written consent. Disclosing the specification to third parties or using its content without written permission from MAGNETEC is strictly forbidden and every offender is liable to pay the corresponding damages.